



**HHC Rx**

# HHC | PRODUCT CATALOG

in partnership with  MHC

The MHC logo consists of four interlocking shapes forming a square, colored in purple, green, blue, and red.



**Easy•Touch®**

**SureLife®**

**ColorSafe®**



## The Trusted Brand in Healthcare

MHC Medical Products designs high-quality consumer diabetic and medical products that provide savings to the end user and greater profits to independent retailers and distributors.

Over time, MHC Medical has turned its brands, like EasyTouch® and SureLife®, into household names; trusted and recommended by healthcare professionals and home health users across North and Central America.

Whether it's innovative products or cost-effective solutions, MHC Medical is committed to improving the quality of care and minimizing costs across the healthcare supply chain.

Call us today to start saving on products that your customers will love and trust!



**FROM TOP TO BOTTOM,  
MHC HAS YOUR SHELVES COVERED!**

*MHC Medical Products designs high-quality consumer diabetic & medical products for a better user experience. With a wide variety of products and attractive packaging, your shelves will be fully-stocked and looking great in no time!*



P: 855.428.3055 • E: Info@HHCPharma.com • www.HHCPharma.com

MHC Medical Products  
**Product List**

**DIABETIC**

*U-100 Insulin Syringes* . . . . . **06**

*Pen Needles* . . . . . **08**

*Twist Lancets* . . . . . **09**

*Alcohol Prep Pads* . . . . . **09**

*BluLink® Glucose Monitoring System* . . . . . **10**

*EasyTouch® Glucose Monitoring System* . . . . . **12**

*HealthPro™ Glucose Monitoring System* . . . . . **12**

*Pressure-Activated Safety Lancets* . . . . . **13**

*Lancing Device* . . . . . **13**

*Hypodermic Needles* . . . . . **14**

*Syringe Barrels* . . . . . **15**

**CLINICAL CARE**

*Safety Pen Needles* . . . . . **16**

*FlipLock™ Needle Technology* . . . . . **17**

*FlipLock™ Safety Syringes & Needles* . . . . . **18**

*Fluringe® FlipLock™ Safety Syringes & Needles* . . . . . **19**

**DIAGNOSTIC**

*Infrared Thermometers* . . . . . **20**

*Pulse Oximeters* . . . . . **21**

*Blood Pressure Monitors* . . . . . **21**

**VIALS & OVALS**

*ColorSafe® Vials* . . . . . **22**

*Reversible Caps* . . . . . **23**

*Child-Resistant Caps* . . . . . **24**

*Snap Caps* . . . . . **24**

*ColorSafe® Ovals* . . . . . **25**

**VET SUPPLIES**

*MVP Vet® U-40 Insulin Syringes* . . . . . **26**

*Veterinary Vials* . . . . . **26**



# EasyTouch<sup>®</sup> U-100 Insulin Syringes

## Comfort you can feel!

EasyTouch<sup>®</sup> Insulin Syringes are designed and manufactured to the highest quality levels possible. Consumers are quick to recognize this high level of quality on a personal level as they experience a more comfortable injection.

The quality level found in our Insulin Syringes can also be found throughout the EasyTouch<sup>®</sup> line of diabetic products.

## Gauges

- 27G – 1cc, 5/8" Needle
- 27G – .5cc & 1cc, 1/2" Needle
- 28G – .5cc & 1cc, 1/2" Needle
- 29G – .5cc & 1cc, 1/2" Needle
- 30G – .3cc, .5cc, & 1cc, 1/2" Needle
- 30G – .3cc, .5cc, & 1cc, 5/16" Needle
- 31G – .3cc, .5cc, & 1cc, 5/16" Needle



## Needle Technology



Our EasyTouch<sup>®</sup> needles are specifically engineered to provide patients with the maximum level of comfort!

- 1 Triple-Bevel Cut for Superior Sharpness
- 2 Anti-Coring Technology
- 3 Electropolished to Remove Burrs
- 4 Thin-Walled for Maximum Flow
- 5 Film-Coated for a Comfortable Injection

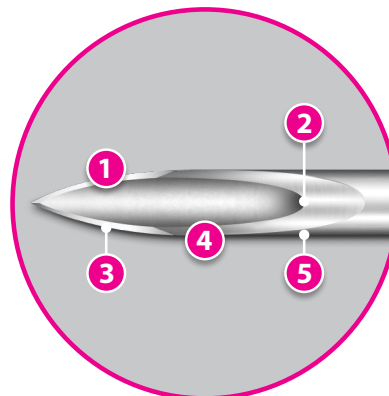



\*Contains No Natural Rubber Latex



## EasyTouch® U-100 Insulin Syringes

Item #	Gauge	mL/CC	Length	NDC# 08496-	Box Color	Box Qty	Case Qty	
827158	27 G	1 cc	5/8 in. (16mm)	7020-01	Orange	100/box	5 retail boxes	
827155	27 G	1 cc	1/2 in. (12.7mm)	2715-01	Orange	100/box	5 retail boxes	
827555	27 G	.5 cc	1/2 in. (12.7mm)	2755-01	Orange	100/box	5 retail boxes	
828155	28 G	1 cc	1/2 in. (12.7mm)	2815-01	Purple	100/box	5 retail boxes	
828555	28 G	.5 cc	1/2 in. (12.7mm)	2855-01	Purple	100/box	5 retail boxes	
829155	29 G	1 cc	1/2 in. (12.7mm)	2915-01	Green	100/box	5 retail boxes	
829555	29 G	.5 cc	1/2 in. (12.7mm)	2955-01	Green	100/box	5 retail boxes	
830155	30 G	1 cc	1/2 in. (12.7mm)	3015-01	Blue	100/box	5 retail boxes	
830555	30 G	.5 cc	1/2 in. (12.7mm)	3055-01	Blue	100/box	5 retail boxes	
830355	30 G	.3 cc	1/2 in. (12.7mm)	3035-01	Blue	100/box	5 retail boxes	
830165	30 G	1 cc	5/16 in. (8mm)	3016-01	Blue	100/box	5 retail boxes	
830565	30 G	.5 cc	5/16 in. (8mm)	3056-01	Blue	100/box	5 retail boxes	
830365	30 G	.3 cc	5/16 in. (8mm)	3036-01	Blue	100/box	5 retail boxes	
831165	31 G	1 cc	5/16 in. (8mm)	3116-01	Yellow	100/box	5 retail boxes	
831565	31 G	.5 cc	5/16 in. (8mm)	3156-01	Yellow	100/box	5 retail boxes	
831365	31 G	.3 cc	5/16 in. (8mm)	3136-01	Yellow	100/box	5 retail boxes	

## EasyTouch® U-100 Insulin Syringes – Individually Wrapped

Item #	Gauge	mL/CC	Length	NDC# 08496-	Box Color	Box Qty	Case Qty	
627155	27 G	1 cc	1/2 in. (12.7mm)	6510-01	Orange	100/box	5 retail boxes	
627555	27 G	.5 cc	1/2 in. (12.7mm)	6520-01	Orange	100/box	5 retail boxes	
628155	28 G	1 cc	1/2 in. (12.7mm)	6511-01	Purple	100/box	5 retail boxes	
628555	28 G	.5 cc	1/2 in. (12.7mm)	6521-01	Purple	100/box	5 retail boxes	
629155	29 G	1 cc	1/2 in. (12.7mm)	6512-01	Green	100/box	5 retail boxes	
629555	29 G	.5 cc	1/2 in. (12.7mm)	6522-01	Green	100/box	5 retail boxes	



# EasyTouch<sup>®</sup> Pen Needles

## Comfort you can feel!

EasyTouch<sup>®</sup> Pen Needles are designed and manufactured to the highest quality levels possible. Consumers are quick to recognize this high level of quality on a personal level as they experience a more comfortable injection.

## Caps are Uniquely Color-Coded

Each EasyTouch<sup>®</sup> Pen Needle cap is color-coded for easy and accurate identification. Confusion is reduced significantly by allowing customers to quickly identify their correct gauge and needle length.

## Needle Technology

- 1 Triple-Bevel Cut for Superior Sharpness
- 2 Anti-Coring Technology
- 3 Electropolished to Remove Burrs
- 4 Thin-Walled for Maximum Flow
- 5 Film-Coated for a Comfortable Injection

\*Contains No Natural Rubber Latex

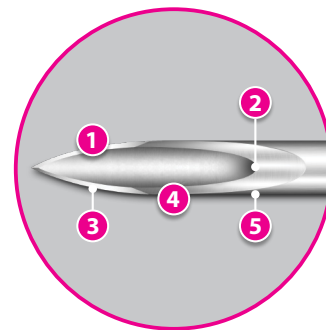

Item #	Gauge	Length	NDC# 08496-	Box Color	Box Qty	Case Qty	
829021	29 G	1/2" (12.7mm)	2902-01	Green	100/box	12 retail boxes	
830561	30 G	5/16" (8mm)	3005-01	Blue	100/box	12 retail boxes	
831361	31 G	3/16" (5mm)	3101-01	Yellow	100/box	12 retail boxes	
831041	31 G	1/4" (6mm)	3104-01	Yellow	100/box	12 retail boxes	
831061	31 G	5/16" (8mm)	3106-01	Yellow	100/box	12 retail boxes	
832081	32 G	5/32" (4mm)	3208-01	Teal	100/box	12 retail boxes	
832361	32 G	3/16" (5mm)	3201-01	Teal	100/box	12 retail boxes	
832041	32 G	1/4" (6mm)	3204-01	Teal	100/box	12 retail boxes	



# EasyTouch® Twist Lancets



## For as little pain as possible!

EasyTouch® Twist Lancets fit most lancing devices. Available in 28G through 33G, our extra-sharp, triple-beveled needles allow users to experience as little pain as possible.

- Color-Coded Packaging by Gauge
- Bilingual Packaging (English/Spanish)
- Contains No Natural Rubber Latex

Item #	Description	NDC# 08496-	Box Color	Box Qty	Case Qty	
828101	28 G Twist Lancet	2810-01	Purple	100/box	10 retail boxes	
830101	30 G Twist Lancet	3010-01	Blue	100/box	10 retail boxes	
832101	32 G Twist Lancet	3210-01	Teal	100/box	10 retail boxes	
833101	33 G Twist Lancet	3310-01	Dark Yellow	100/box	10 retail boxes	

# EasyTouch® Alcohol Prep Pads



## Quality you can see!

EasyTouch® Alcohol Prep Pads are medium, 2-ply, spun lace hospital-style gauze. EasyTouch® Prep Pads are sterilized with gamma radiation.

Item #	Description	NDC# 42423-	Box Color	Box Qty	Case Qty	
802711	100ct Alcohol Prep Pads	271-01	White/Green	100/box	50 retail boxes	
802712	200ct Alcohol Prep Pads	271-02	White/Green	200/box	25 retail boxes	

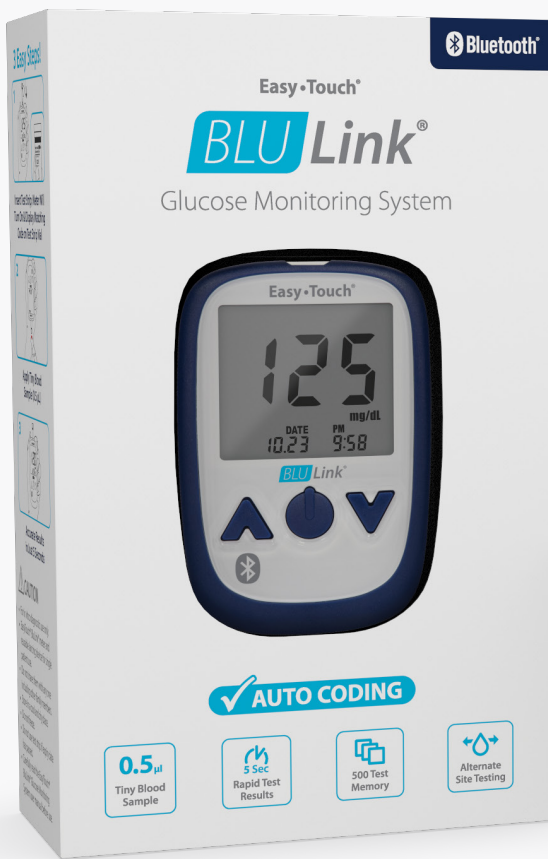

# EasyTouch® BluLink® Glucose Monitoring System

## Product Features

**Bluetooth Connectivity**  
*Wirelessly Log to Your Phone*

**Auto-coding**  
*100% Code Free*

**Tiny Blood Size**  
*0.5 Microliter Blood Sample*

**Fast Test Time**  
*Results in 5 Seconds*

**Alternate Site Testing**  
*Fingertip, Palm & Forearm*

**Status of User Condition**  
*Activity, Medication & Meal Recognition*

**Memory**  
*500 Most Recent Results*

**Test Strip Ejector**  
*Safely Discard Used Test Strips*

## Kit Contents

- EasyTouch® BluLink® Meter
- Deluxe Carrying Case
- Lancing Device
- 10 Twist Lancets
- Batteries Included
- Instruction Manual
- Quick Reference Guide
- Logbook

## Need to Know

- 1 Test Strip Ejector
- 2 Easy-to-read Display
- 3 Navigation



*One of the world's most accurate meters! +/- 15% Accuracy*



## BLU Link<sup>®</sup> Smartphone Application

The BLU Link<sup>®</sup> smartphone application offers an attractive, organized, and easy-to-use solution for logging your glucose test results.

After your BLU Link<sup>®</sup> Glucose Meter and smartphone app are paired, your results will transfer automatically when you eject your test strip!

The BLU Link<sup>®</sup> smartphone app is available for free on iOS and Android Devices



Item #	Description	NDC# 08496-	Box Color	Box Qty	Case Qty	
849001	Glucose Monitoring System	7013-01	White/Blue	1/box	6 retail boxes	
849050	Glucose Test Strips (50ct)	7015-01	White/Blue	50/box	24 retail boxes	
849011	Glucose Control Solution	7017-01	White/Blue	1/box	12 retail boxes	

# EasyTouch® Glucose Monitoring System



## Product Features

- No Coding
- 0.5 Microliter Blood Sample
- Results in 5 Seconds
- 4 Alarm Reminders
- 300 Result History
- 7, 14, & 30-Day Averaging
- Auto On/Off

## Kit Contents

- EasyTouch® Meter
- Deluxe Carrying Case
- 10 Twist Lancets
- Lancing Device
- User Manual & Logbook
- Quick Reference Guide
- Batteries Included

One of the world's most accurate meters! **+/- 15% Accuracy**

Item #	Description	NDC# 08496-	Box Color	Box Qty	Case Qty	
807001	Glucose Monitoring System	0807-01	Blue/Green	1/box	6 retail boxes	
807050	Glucose Test Strips (50ct)	0807-05	Blue/Green	50/box	24 retail boxes	
810001	Control Solution	0810-01	Blue/Green	1/box	12 retail boxes	

# EasyTouch® HealthPro™ Glucose Monitoring System



## Product Features

- No Coding
- 0.5 Microliter Blood Sample
- Results in 5 Seconds
- 365 Result History
- Auto On/Off
- **Test Strip Ejector**
- **Backlit Screen**

## Kit Contents

- EasyTouch® HealthPro™ Meter
- Deluxe Carrying Case
- 10 Twist Lancets
- Lancing Device
- User Manual & Logbook
- Quick Reference Guide
- Batteries Included

One of the world's most accurate meters! **+/- 15% Accuracy**

Item #	Description	NDC# 08496-	Box Color	Box Qty	Case Qty	
809001	Glucose Monitoring System	7000-01	White/Blue	1/box	6 retail boxes	
809050	Glucose Test Strips (50ct)	7002-01	White/Blue	50/box	24 retail boxes	
809011	Glucose Control Solution	7004-01	White/Blue	1/box	12 retail boxes	

# EasyTouch® Pressure-Activated Safety Lancets



## Safety for caregivers... Comfort for patients!

EasyTouch® Pressure-Activated Safety Lancets are a fast and simple option for caregivers and diabetics on the go.

- Color-Coded Packaging by Gauge
- Bilingual Packaging (English/Spanish)
- Contains No Natural Rubber Latex

Item #	Gauge	Length	NDC# 08496-	Box Color	Box Qty	Case Qty	
821241	21 G	2.4mm	2141-01	Dark Blue	100/box	10 retail boxes	
823221	23 G	2.2mm	2322-01	Gray	100/box	10 retail boxes	
826081	26 G	1.8mm	2608-01	Dark Green	100/box	10 retail boxes	
828081	28 G	1.8mm	2808-01	Purple	100/box	10 retail boxes	
830061	30 G	1.6mm	3006-01	Blue	100/box	10 retail boxes	

# EasyTouch® Lancing Device



## A better choice for greater control!

Not all lancing devices are alike. The EasyTouch® Lancing Device is quick and without vibration, which helps to eliminate pain.

With five depth settings and an Alternate Site Testing tip, the EasyTouch® Lancing Device is the trusted choice for diabetic customers.

Item #	Description	NDC# 08496-	Box Color	Box Qty	Case Qty	
808001	Lancing Device w/ Ejector	0808-01	White/Green	1/box	10 retail boxes	

# EasyTouch® Hypodermic Needles



## Product Features

Our EasyTouch® needles are specifically engineered to provide patients with the maximum level of comfort.

- Triple-Bevel Cut for Superior Sharpness
- Anti-Coring Technology
- Electropolished to Remove Burrs
- Thin-Walled for Maximum Flow
- Film-Coated for a Comfortable Injection
- Contains No Natural Rubber Latex



**Fits All Standard Luer Lock & Luer Slip Syringe Barrels**

Item #	Gauge	Length	NDC# 08496-	Box Color	Box Qty	Case Qty	
801601	16G	1" (25mm)	0303-01	Purple	100/box	6 retail boxes	
801607	16G	1.5" (40mm)	0304-01	Purple	100/box	6 retail boxes	
801801	18G	1" (25mm)	0305-01	Dark Pink	100/box	6 retail boxes	
801807	18G	1.5" (40mm)	0306-01	Dark Pink	100/box	6 retail boxes	
802001	20G	1" (25mm)	0311-01	Lime Green	100/box	6 retail boxes	
802007	20G	1.5" (40mm)	0312-01	Lime Green	100/box	6 retail boxes	
802101	21G	1" (25mm)	0313-01	Dark Blue	100/box	6 retail boxes	
802107	21G	1.5" (40mm)	0314-01	Dark Blue	100/box	6 retail boxes	
802201	22G	1" (25mm)	0318-01	Pink	100/box	6 retail boxes	
802207	22G	1.5" (40mm)	0319-01	Pink	100/box	6 retail boxes	
802301	23G	1" (25mm)	0322-01	Gray	100/box	6 retail boxes	
802307	23G	1.5" (40mm)	0324-01	Gray	100/box	6 retail boxes	
802500	25G	5/8" (16mm)	0329-01	Red	100/box	6 retail boxes	
802501	25G	1" (25mm)	0331-01	Red	100/box	6 retail boxes	
802507	25G	1.5" (40mm)	0332-01	Red	100/box	6 retail boxes	
802705	27G	1/2" (12.7mm)	0339-01	Orange	100/box	6 retail boxes	
803005	30G	1/2" (12.7mm)	0348-01	Blue	100/box	6 retail boxes	

# EasyTouch® Syringe Barrels (Luer Lock)



## Simple & Easy

A clear barrel is a better barrel! EasyTouch® Syringe Barrels are designed and manufactured to be ultra clear with well-defined markings. Designed with minimal dead space.

- Ultra-Clear Barrel
- Well-Defined Markings
- Luer Lock Connections
- Smooth Surface for Low-Friction Dispensing
- Contains No Natural Rubber Latex



1 cc Luer Lock



3 cc Luer Lock

Item #	Description	mL/CC	NDC# 08496-	Box Color	Box Qty	Case Qty	
802015	Luer Lock Barrel (INS)	1 mL	0164-01	Dark Orange	100	6 retail boxes	
802010	Luer Lock Barrel (TB)	1 mL	0155-01	Dark Orange	100	6 retail boxes	
802030	Luer Lock Barrel (TB)	3 mL	0159-01	Dark Orange	100	6 retail boxes	
802050	Luer Lock Barrel (TB)	5 mL	0161-01	Dark Orange	50	6 retail boxes	
802100	Luer Lock Barrel (TB)	10 mL	0163-01	Dark Orange	50	6 retail boxes	
802024	Luer Lock Barrel (TB)	20 mL	0176-01	Dark Orange	48	6 retail boxes	
802064	Luer Lock Barrel (TB)	60 mL	0178-01	Dark Orange	40	6 retail boxes	



# EasyTouch<sup>®</sup> Safety Pen Needles

## Reduce the Chance of Accidental Needlesticks!

EasyTouch<sup>®</sup> Safety Pen Needles feature a protective shield that automatically locks into place after injection to help reduce the occurrence of needlestick injuries.

- Automatic Protective Shield
- Easy to Use
- Needle Design for Maximum Patient Comfort
  - Triple-Bevel Cut Tip
  - Electropolished to Remove Burrs
  - Film-Coated for a Smoother Injection
- Contains No Natural Rubber Latex

## Colored Hub Clearly Indicates When the Safety Shield Has Been Activated



Item #	Gauge	Length	NDC# 08496-	Box Color	Box Qty	Case Qty	
829536	29 G	3/16" (5mm)	2905-01	Green	100/box	8 retail boxes	
829856	29 G	5/16" (8mm)	2908-01	Green	100/box	8 retail boxes	
830536	30 G	3/16" (5mm)	3003-01	Blue	100/box	8 retail boxes	
830856	30 G	5/16" (8mm)	3008-01	Blue	100/box	8 retail boxes	



Easy•Touch®

# FLIPLock™

SAFETY SYRINGE **TECHNOLOGY**

## Safe and Effective!

EasyTouch® FlipLock™ Safety Syringes offer an easy and simple solution in caregiver protection. After injection, just flip the protective shield over the needle until it clicks and locks in place. Hands and fingers stay away from the exposed needle. Simple, smart, and cost-effective.

## Features & Benefits

- Easy to Use
- Protective Cover Shields Needle After Use
- Familiar Technology Requires Limited Training
- Multi-Lock Safety System
- FlipLock™ Needles Fit All Standard Luer Lock and Luer Slip Syringe Barrels
- Contains No Natural Rubber Latex



## Safe Injections Are as Easy as 1, 2, 3!

**1 Load Syringe**  
Pull the plunger back to load the syringe

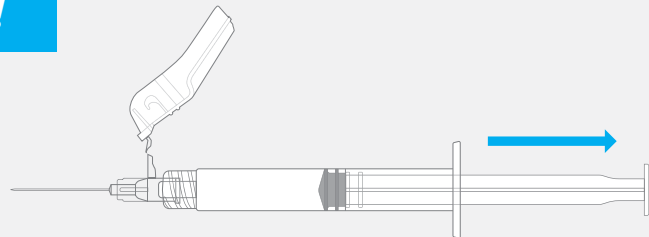

**2 Inject**  
Push the plunger in one smooth motion to administer medication

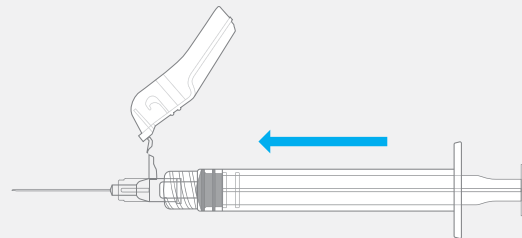

**3 Flip**  
Flip the protective shield over the used needle until it clicks into place. Discard according to local regulations.

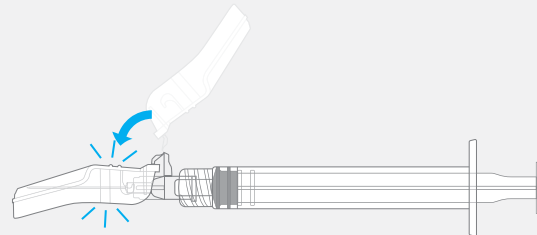

## EasyTouch® FlipLock™ Safety Syringes



### Product Features

EasyTouch® FlipLock™ Safety Syringes offer an easy and simple solution in caregiver protection. After injection, just flip the protective shield over the needle until it clicks and locks into place. Hands and fingers stay away from the exposed needle. Simple, smart, and cost effective.

Item #	Gauge	mL/CC	Length	NDC# 08496-	Box Color	Box Qty	Case Qty	
822231	22 G	3 mL	1" (25mm)	0261-01	White/Pink	100/box	6 retail boxes	
822237	22 G	3 mL	1.5" (40mm)	0262-01	White/Pink	100/box	6 retail boxes	
822331	23 G	3 mL	1" (25mm)	0263-01	White/Gray	100/box	6 retail boxes	
822337	23 G	3 mL	1.5" (40mm)	0293-01	White/Gray	100/box	6 retail boxes	

## EasyTouch® FlipLock™ Needles



### Product Features

EasyTouch® FlipLock™ Needles offer the same technology and quality as our other FlipLock™ products. Compatible with luer lock and luer slip connections and perfect to use with your prefilled syringes and multi-dose vials.

*For Syringe Barrels, see page 15 ➔*

Item #	Gauge	Length	NDC# 08496-	Box Color	Box Qty	Case Qty	
811801	18 G	1" (25mm)	0186-01	White/Light Pink	50/box	5 retail boxes	
811807	18 G	1.5" (40mm)	0187-01	White/Light Pink	50/box	5 retail boxes	
812300	23 G	5/8" (16mm)	0200-01	White/Gray	50/box	5 retail boxes	
812301	23 G	1" (25mm)	0201-01	White/Gray	50/box	5 retail boxes	
812307	23 G	1.5" (40mm)	0202-01	White/Gray	50/box	5 retail boxes	
812501	25 G	1" (25mm)	0204-01	White/Red	50/box	5 retail boxes	
812705	27 G	1/2" (12.7mm)	0207-01	White/Orange	50/box	5 retail boxes	
812701	27 G	1" (25mm)	0221-01	White/Orange	50/box	5 retail boxes	
813006	30 G	5/16" (8mm)	0218-01	White/Blue	50/box	5 retail boxes	
813005	30 G	1/2" (12.7mm)	0217-01	White/Blue	50/box	5 retail boxes	
813106	31 G	5/16" (8mm)	0219-01	White/Yellow	50/box	5 retail boxes	



# EasyTouch® Fluringe® FlipLock™ Safety Syringes and Needles

## The Flu Vaccine Syringe

EasyTouch® Fluringe® FlipLock™ Safety Syringes and Needles offer the same technology and high quality as our other FlipLock™ products, but with the specifications you look for in a syringe when administering the flu vaccine.

The EasyTouch® Fluringe® FlipLock™ Needles fit luer lock and luer slip connections and are perfect to use with your prefilled syringes and multi-dose vials.



## Safety Syringes

Item #	Gauge	mL/CC	Length	NDC# 08496-	Box Color	Box Qty	Case Qty	
822518	25 G	1 mL	5/8 in (16mm)	7009-01	White/Red	100/box	6 retail boxes	
822511	25 G	1 mL	1 in (25mm)	7010-01	White/Red	100/box	6 retail boxes	
825230	25 G	3 mL	5/8 in (16mm)	7011-01	White/Red	100/box	6 retail boxes	
825231	25 G	3 mL	1 in (25mm)	7012-01	White/Red	100/box	6 retail boxes	

## Needles

Item #	Gauge	mL/CC	Length	NDC# 08496-	Box Color	Box Qty	Case Qty	
815200	25 G	-	5/8 in (16mm)	7007-01	White/Red	50/box	6 retail boxes	
815201	25 G	-	1 in (25mm)	7008-01	White/Red	50/box	6 retail boxes	



# SureLife® ThinTemp® and EasyTouch® Infrared Thermometers

## Accurate & Easy to Use

The EasyTouch® and SureLife® ThinTemp® Infrared Thermometers offer an attractive and reliable way to take body temperature measurements from the forehead.

The non-contact, compact, one-button design makes operation safe, convenient, and simple.

- Fast Measurement*
- Fever Warning*
- Low Battery Indicator*
- Automatic Shut Off*
- 32 Most Recent Results*

Item #	Description	NDC# 08496-	Color	Box Qty	Case Qty	
860106	SureLife® ThinTemp® Infrared Thermometer	7018-01	Black	1/box	6 retail boxes	
860107	EasyTouch® Infrared Thermometer	7019-01	White	1/box	6 retail boxes	

# SureLife® Clearwave Pulse Oximeters



## Product Features

- Accurate Reading of Oxygen Saturation and Pulse Rate
- Low-Battery Indicator
- One-Button Operation
- Soft-Padded Finger Insert
- Multi-Directional OLED Display (Clearwave II Only)

Item #	Description	NDC# 08496-	Color	Box Qty	Case Qty	
860310	Clearwave Pulse Oximeter	0501-01	Black	1/box	10 retail boxes	
860320	Clearwave II Pulse Oximeter	0502-01	White	1/box	10 retail boxes	

# SureLife® Blood Pressure Monitors



## Fast, Accurate, and Less Expensive!

SureLife® Blood Pressure Monitors offer an attractive and reliable way to take blood pressure measurements.

Both wrist and upper-arm models come in two styles: Classic and Premium. The Classic models provide incredible value with great features such as jumbo LCD screens, multi-user memory settings, and irregular heartbeat indicators. The Premium models add to these features with voice readout and a universal arm cuff for the upper-arm unit.

Item #	Description	NDC# 08496-	Box Color	Box Qty	Case Qty	
860211	Wrist Blood Pressure Monitor	0211-01	White/Green	1/box	24 retail boxes	
860212	Talking Wrist Blood Pressure Monitor	0212-01	White/Orange	1/box	24 retail boxes	
860213	Arm Blood Pressure Monitor	0213-01	White/Green	1/box	12 retail boxes	
860214	Talking Arm Blood Pressure Monitor	0214-01	White/Orange	1/box	12 retail boxes	



# ColorSafe® Vials

- ✓ MORE CHOICES
- ✓ MORE SAVINGS
- ✓ MORE PIZAZZ



Our **Smart Case** gives you dram size, color, and quantity on 4 sides!

## Features & Benefits

- ✓ Available in five beautiful colors
- ✓ Quality equal to America's largest vial suppliers at incredible savings
- ✓ Helps improve patient compliance to medications
- ✓ 100% satisfaction guaranteed

## ✓ 3 Cap Styles Available



Child-Resistant Caps



Snap Caps











Reversible Caps

ColorSafe®  
Vials w/ Reversible Caps (RC)



Item #	Description	UPC#	Color	Case Qty	
850801	8 dram – Reversible Cap (RC)	0 84960 80141 9	Amber	400	
850802	8 dram – Reversible Cap (RC)	0 84960 80241 6	Blue	400	
850803	8 dram – Reversible Cap (RC)	0 84960 80341 3	Green	400	
850804	8 dram – Reversible Cap (RC)	0 84960 80441 0	Violet	400	
850805	8 dram – Reversible Cap (RC)	0 84960 80541 7	Red	400	
851301	13 dram – Reversible Cap (RC)	0 84961 30127 7	Amber	275	
851302	13 dram – Reversible Cap (RC)	0 84961 30227 4	Blue	275	
851303	13 dram – Reversible Cap (RC)	0 84961 30327 1	Green	275	
851304	13 dram – Reversible Cap (RC)	0 84961 30427 8	Violet	275	
851305	13 dram – Reversible Cap (RC)	0 84961 30527 5	Red	275	
851601	16 dram – Reversible Cap (RC)	0 84961 60126 1	Amber	240	
851602	16 dram – Reversible Cap (RC)	0 84961 60226 8	Blue	240	
851603	16 dram – Reversible Cap (RC)	0 84961 60326 5	Green	240	
851604	16 dram – Reversible Cap (RC)	0 84961 60426 2	Violet	240	
851605	16 dram – Reversible Cap (RC)	0 84961 60526 9	Red	240	
852001	20 dram – Reversible Cap (RC)	0 84962 00127 5	Amber	270	
852002	20 dram – Reversible Cap (RC)	0 84962 00227 2	Blue	270	
852003	20 dram – Reversible Cap (RC)	0 84962 00327 9	Green	270	
852004	20 dram – Reversible Cap (RC)	0 84962 00427 6	Violet	270	
852005	20 dram – Reversible Cap (RC)	0 84962 00527 3	Red	270	
853001	30 dram – Reversible Cap (RC)	0 84963 00121 2	Amber	195	
853002	30 dram – Reversible Cap (RC)	0 84963 00221 9	Blue	195	
853003	30 dram – Reversible Cap (RC)	0 84963 00321 6	Green	195	
853004	30 dram – Reversible Cap (RC)	0 84963 00421 3	Violet	195	
853005	30 dram – Reversible Cap (RC)	0 84963 00521 0	Red	195	
854001	40 dram – Reversible Cap (RC)	0 84964 00116 7	Amber	130	
854002	40 dram – Reversible Cap (RC)	0 84964 00216 4	Blue	130	
854003	40 dram – Reversible Cap (RC)	0 84964 00316 1	Green	130	
854004	40 dram – Reversible Cap (RC)	0 84964 00416 8	Violet	130	
854005	40 dram – Reversible Cap (RC)	0 84964 00516 5	Red	130	
856001	60 dram – Reversible Cap (RC)	0 84966 00190 5	Amber	90	
856002	60 dram – Reversible Cap (RC)	0 84966 00290 2	Blue	90	
856003	60 dram – Reversible Cap (RC)	0 84966 00390 9	Green	90	
856004	60 dram – Reversible Cap (RC)	0 84966 00490 6	Violet	90	
856005	60 dram – Reversible Cap (RC)	0 84966 00590 3	Red	90	

## ColorSafe® Vials w/ Child-Resistant Caps (CRC)

Plus 5% Additional  
Snap Caps Included

Item #	Description	UPC#	Color	Case Qty	
850821	8 dram – Child-Resistant Cap (CRC)	0 84960 82141 7	Amber	410	
850822	8 dram – Child-Resistant Cap (CRC)	0 84960 82241 4	Blue	410	
850823	8 dram – Child-Resistant Cap (CRC)	0 84960 82341 1	Green	410	
851321	13 dram – Child-Resistant Cap (CRC)	0 84961 32131 2	Amber	320	
851322	13 dram – Child-Resistant Cap (CRC)	0 84961 32231 9	Blue	320	
851323	13 dram – Child-Resistant Cap (CRC)	0 84961 32331 6	Green	320	
851621	16 dram – Child-Resistant Cap (CRC)	0 84961 62126 9	Amber	270	
851622	16 dram – Child-Resistant Cap (CRC)	0 84961 62226 6	Blue	270	
851623	16 dram – Child-Resistant Cap (CRC)	0 84961 62326 3	Green	270	
852021	20 dram – Child-Resistant Cap (CRC)	0 84962 02136 5	Amber	360	
852022	20 dram – Child-Resistant Cap (CRC)	0 84962 02236 2	Blue	360	
852023	20 dram – Child-Resistant Cap (CRC)	0 84962 02336 9	Green	360	
853021	30 dram – Child-Resistant Cap (CRC)	0 84963 02127 2	Amber	240	
853022	30 dram – Child-Resistant Cap (CRC)	0 84963 02227 9	Blue	240	
853023	30 dram – Child-Resistant Cap (CRC)	0 84963 02327 6	Green	240	
854021	40 dram – Child-Resistant Cap (CRC)	0 84964 02118 9	Amber	180	
854022	40 dram – Child-Resistant Cap (CRC)	0 84964 02218 6	Blue	180	
854023	40 dram – Child-Resistant Cap (CRC)	0 84964 02318 3	Green	180	
856021	60 dram – Child-Resistant Cap (CRC)	0 84966 02111 8	Amber	115	
856022	60 dram – Child-Resistant Cap (CRC)	0 84966 02211 5	Blue	115	
856023	60 dram – Child-Resistant Cap (CRC)	0 84966 02311 2	Green	115	

## ColorSafe® Vials w/ Snap Caps (SC)

Item #	Description	UPC#	Color	Case Qty	
850811	8 dram – Snap Cap (SC)	0 84960 81150 0	Amber	500	
851311	13 dram – Snap Cap (SC)	0 84961 31136 8	Amber	360	
851611	16 dram – Snap Cap (SC)	0 84961 61130 7	Amber	300	
852011	20 dram – Snap Cap (SC)	0 84962 01144 1	Amber	300	
853011	30 dram – Snap Cap (SC)	0 84963 01130 3	Amber	280	
854011	40 dram – Snap Cap (SC)	0 84964 01122 7	Amber	190	
856011	60 dram – Snap Cap (SC)	0 84966 01114 0	Amber	140	



ColorSafe®  
**Graduated Ovals (CRC)**



**Cases**

Item #	Description	UPC#	Color	Case Qty	
850231	2 oz. – Child-Resistant Cap (CRC)	0 84960 23110 0	Amber	100	
850431	4 oz. – Child-Resistant Cap (CRC)	0 84960 43110 4	Amber	100	
850631	6 oz. – Child-Resistant Cap (CRC)	0 84960 63110 8	Amber	100	
850831	8 oz. – Child-Resistant Cap (CRC)	0 84960 83175 1	Amber	75	
851231	12 oz. – Child-Resistant Cap (CRC)	0 84961 23150 5	Amber	50	
851631	16 oz. – Child-Resistant Cap (CRC)	0 84961 63150 3	Amber	50	

**Boxes**

Item #	Description	UPC#	Color	Box Qty	
880231	2 oz. – Child-Resistant Cap (CRC)	0 84960 23125 4	Amber	25	
880431	4 oz. – Child-Resistant Cap (CRC)	0 84960 43125 8	Amber	25	
880631	6 oz. – Child-Resistant Cap (CRC)	0 84960 63125 2	Amber	25	
880831	8 oz. – Child-Resistant Cap (CRC)	0 84960 83125 6	Amber	25	
881231	12 oz. – Child-Resistant Cap (CRC)	0 84961 23125 3	Amber	25	
881631	16 oz. – Child-Resistant Cap (CRC)	0 84961 63125 1	Amber	25	

# MVP Vet® U-40 Insulin Syringes



## Product Features

MVP Vet® U-40 Insulin Syringes are designed and manufactured to the same high-quality levels as EasyTouch® Insulin Syringes. Consumers are quick to recognize this as their pets experience a more comfortable injection.

- Contains No Natural Rubber Latex

Item #	Gauge	mL/CC	Length	NDC# 08496-	Box Color	Box Qty	Case Qty	
819150	29 G	1 cc	1/2 in. (12.7mm)	3915-01	White/Green	100/box	5 retail boxes	
819550	29 G	.5 cc	1/2 in. (12.7mm)	3955-01	White/Green	100/box	5 retail boxes	

## Veterinary Vials w/ Reversible Caps (RC)



## Product Features

- Available in Two Distinct Colors
- Available in RC Caps (Included)
- Easy-to-Read Information on Each Side of the Box
- Add Elegance and Pizzazz to Dispensing
- Improved Patient Compliance to Meds

Item #	Description	UPC#	Color	Case Qty	
850862	8 dram – Reversible Cap (RC)	0 84960 86241 0	Blue	410	
850863	8 dram – Reversible Cap (RC)	0 84960 86341 7	Green	410	
851362	13 dram – Reversible Cap (RC)	0 84961 36231 5	Blue	275	
851363	13 dram – Reversible Cap (RC)	0 84961 36331 2	Green	275	
851662	16 dram – Reversible Cap (RC)	0 84961 66226 2	Blue	240	
851663	16 dram – Reversible Cap (RC)	0 84961 66326 9	Green	240	
852062	20 dram – Reversible Cap (RC)	0 84962 06236 8	Blue	270	
852063	20 dram – Reversible Cap (RC)	0 84962 06336 5	Green	270	
853062	30 dram – Reversible Cap (RC)	0 84963 06227 5	Blue	195	
853063	30 dram – Reversible Cap (RC)	0 84963 06327 2	Green	195	
854062	40 dram – Reversible Cap (RC)	0 84964 06218 2	Blue	130	
854063	40 dram – Reversible Cap (RC)	0 84964 06318 9	Green	130	
856062	60 dram – Reversible Cap (RC)	0 84966 06211 1	Blue	90	
856063	60 dram – Reversible Cap (RC)	0 84966 06311 8	Green	90	



**HHCPharma Contact Info:**

**P:** 855.428.3055

**E:** [Info@HHCPharma.com](mailto:Info@HHCPharma.com)

**[www.HHCPharma.com](http://www.HHCPharma.com)**

11930 Kemper Springs Dr.  
Ste. 200  
Cincinnati, OH 45240

---

**MHC Contact Info:**

**P:** 877.358.4342

**[www.MHCmed.com](http://www.MHCmed.com)**

8695 Seward Springs Rd.  
Fairfield, OH 45011